



Module: CSD100
OWNER'S MANUAL

Congratulations!

Thank you for purchasing this digital drum set. The drum set has been developed to act and play like a drum set but with greater ease. Before you use the instrument, we recommend you to read through this manual.

Taking care of your digital drum set

Location

- Do not expose the unit to the following conditions to avoid deformation, discoloration or more serious damage.
- Direct sunlight.
- High temperature (near a heat source, or in car during the day time).
- Disconnect all cables before moving

Power Supply

- Make sure to use the suitable AC adaptor, and also make sure the AC outlet voltage at your country matches the input voltage specified on the AC adaptor's label.
- Turn the power switch OFF when the Instrument is not in use.
- An AC adaptor should be unplugged from the AC outlet if the instrument is not to be used for an extended period of time.
- Unplug the AC adaptor during electric storms.
- Avoid plugging the AC adaptor into the same AC outlet as appliance with high power consumption, such as electric heaters or ovens. Also avoid using multi-plug adaptors since these can result in reducing the sound quality, operation errors, and possibly damage.

Turn Power OFF When Making Connections

- To avoid damage to the instrument and other devices to which it is connected, turn the power switches of all related device OFF prior to connecting or disconnecting cables.

Handling and Transport

- Never apply excessive force to the controls, connectors or other parts of the instrument.
- Always unplug cables by gripping the plug firmly, but not pulling on the cable.
- Disconnect all cables before moving the instrument.
- Physical shocks caused by dropping, bumping, or placing heavy objects on the instrument can result in scratches and more serious damage.

Cleaning

- Clean the unit with a dry soft cloth.
- A Slightly damp cloth may be used to remove stubborn grime and dirt.
- Never use cleaners such as alcohol or thinner.
- Avoid placing vinyl object on top of the unit (vinyl can stick to and discolor the surface).

Electrical Interference

- This instrument contains digital circuitry and may cause interference if placed too close to radio or television receivers. If this occurs, move the instrument further away from the affected equipment.

1. Module function

Front panel

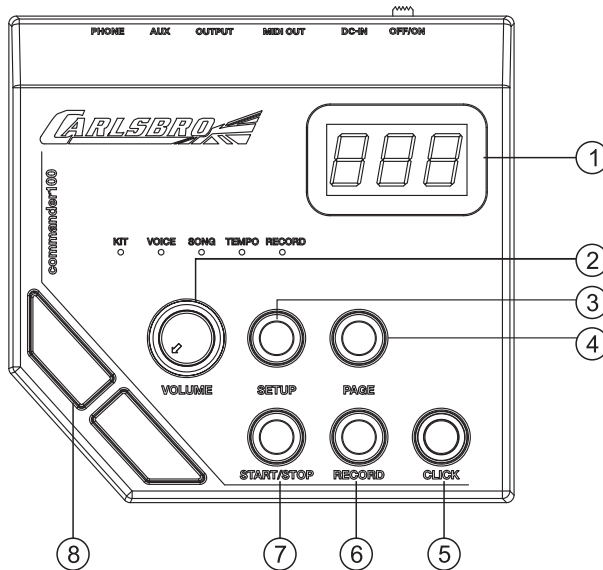

- ① LED display
Displays the menu parameters.
- ② VOLUME
Adjusts the headphones and output volume.
- ③ SET UP
Enters into practical setting interface, separately adjusts the parameters of KIT/VOICE/SONG/TEMPO.
- ④ PAGE
Views the sub menu of VOICE/SONG/TEMPO.
- ⑤ CLICK
Turns on/off the metronome.
- ⑥ RECORD
Records the drum sound.
- ⑦ START/STOP
Starts/stops the instrument playing or recording.
- ⑧ [+/-]
Adjusts the parameters, e.g. drum kit, Voice, etc.(Hold the button to change value quickly)

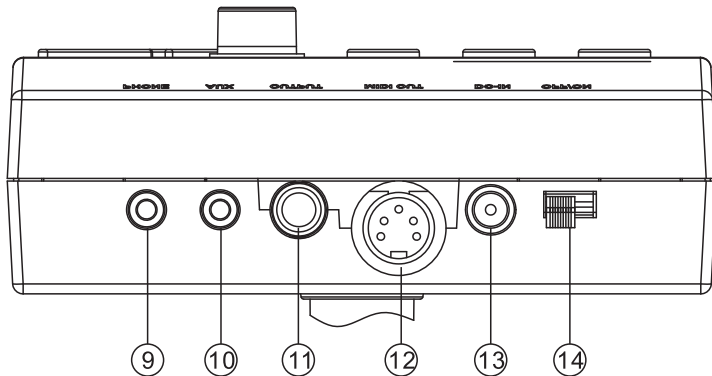

⑨ PHONE

Stereo headphone connector.

⑩ AUX

External stereo input connection, e.g. MP3 or CD player.

⑪ OUTPUT

The stereo output connector to connect with audio system or drum amp, mono output.

⑫ MIDI OUT

Connects with external MIDI devices(The drum MIDI signal outputs via MIDI OUT to external audio source.)

⑬ DC-IN

Power adapter connector.

⑭ ON/OFF

Switches the power on and off.

Rear panel

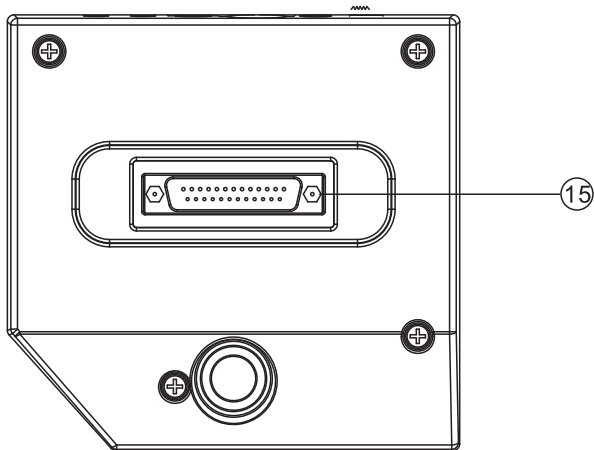

- ⑮ Trigger in connector
D-SUB pad signal input connector.

2. Connect with external devices

Connecting with audio system or drum amplifier

Connect on end with OUTPUT of the module, and the other end with audio system or drum amplifier.

Note: The volume is controlled by the module volume knob and device volume knob.

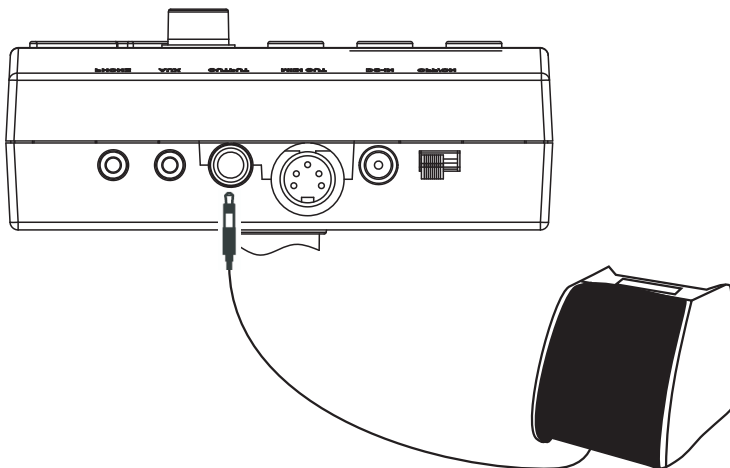

Connect with Headphones

Connect the phone with 1/8" stereo connector on the module (if 1/4" headphone is used, use an adaptor). The volume is controlled by the volume knob on the module.

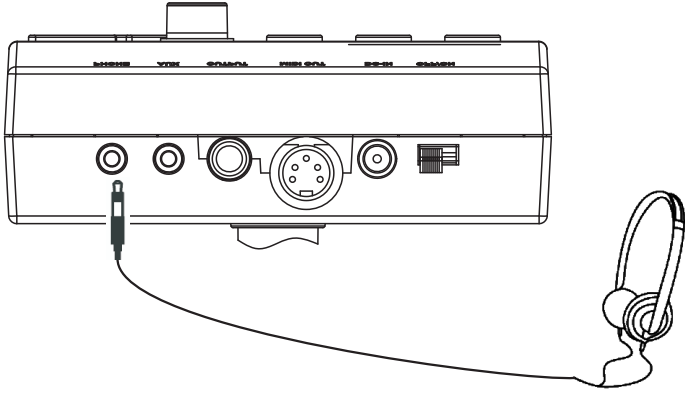

Connect with MP3 or CD player

Connect the output of MP3 or CD player with AUX IN connector of the module. The input signal can be mixed with the drum signal. User can strike the pad according to the metronome click of input signal.

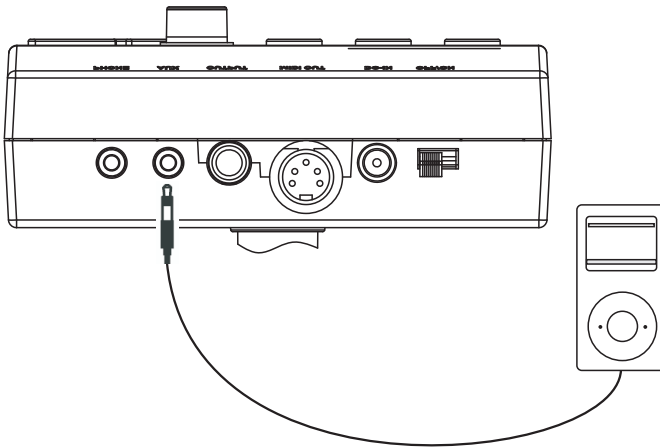

Connect with PC

Connect PC via MIDI port

MIDI OUT: delivers pad signal to PC.

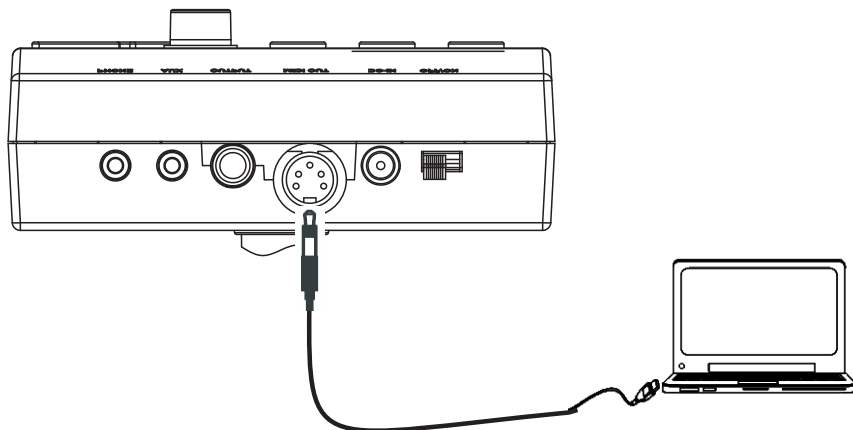

Power supply

- 1). Turn off the module power switch.
- 2). Connect the power supply with DC IN connector.
- 3). Confirm all the pads are correctly connected. Set the module volume to minimum, then turn on the power switch of the module. The display lights up and it enters into the drum kit menu.

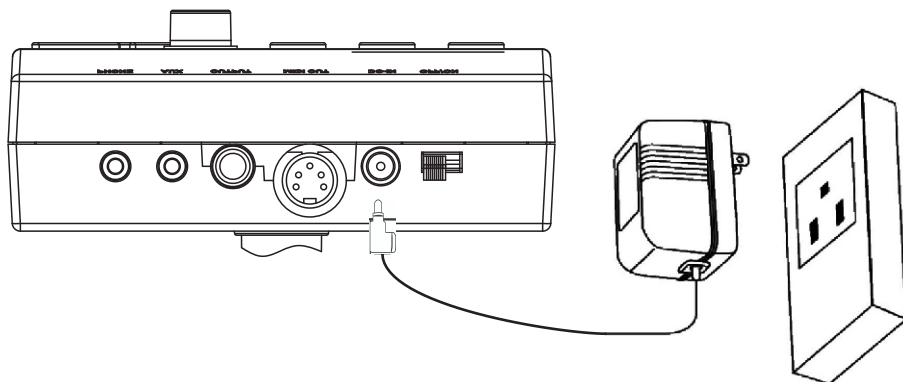

turn off the power switch before connecting with other devices.

5. Operation

Adjust the master volume

Strike the pads and adjust the volume knob for proper master volume.

Preset drum kit: KIT01---10

1. Power on to enter drum kit selection, the KIT LED lights up(the display shows drum kit number saved last time before power-off);
2. Press [SET UP] key to enter drum kit setting, the KIT LED lights up;
(The corresponding mode LED will also light up in mode switch)

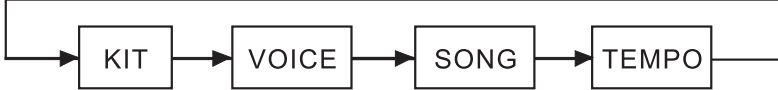

3. In drum kit mode, LED shows the current drum kit number, press[+/-] key to switch the drum kit and select any drum kit as current drum kit.

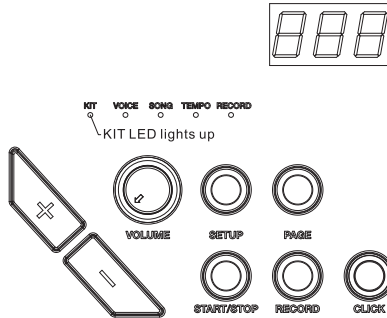

Voice

The module has 108 voices, including the GM voices.

1. Select voice

Press[SET UP] key to enter voice menu, the Voice LED lights up, press [+/-] key to switch the voice(auto save, restore preset drum kit if outage).

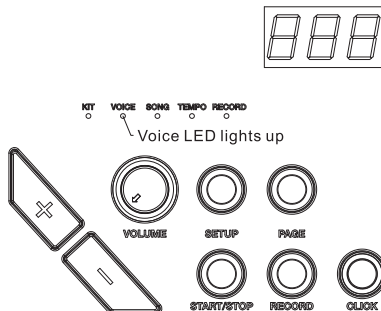

2. Adjust volume

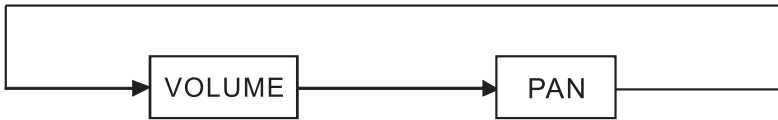

- (1) In voice mode, press [PAGE] key to enter into volume setting, strike a pad, the three LED shows LXX (XX refers to volume value);
- (2) Press [+/-] key to switch the volume, range 0-32(auto save, restore preset drum kit if outage).

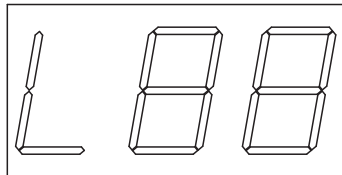

3. Adjust pan

- (1) In voice mode, press [PAGE] key to enter into the pan setting, directly strike the pad of which the pan to be adjusted, the three LED shows PXX (XX refers to pan value);
- (2) Press [+/-] key to switch the pan, range 0-32(auto save, restore preset drum kit if outage).

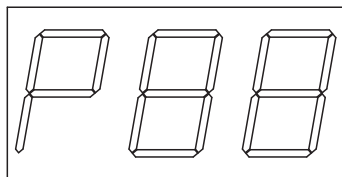

1. Song selecting

- (1) Press [SET UP] key to enter into song menu, the SONG LED lights up.
- (2) Press [+/-] key to switch the song, range 001-010 (non-cycle);

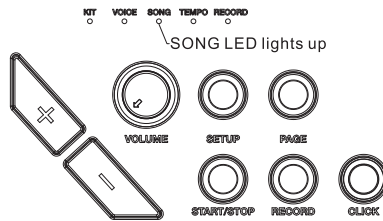
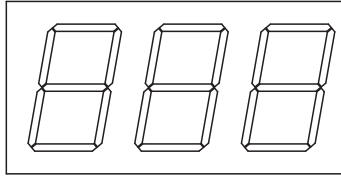

2. Song playing

- (1) Press [START/STOP] key to play the selected song. During playing, change the song via [+/-] key.

The overall volume is controlled by the module volume knob;

- (2) Before song mode, directly press [START/STOP] key to play the song;
- (3) After playing, songs will stop automatically; during playing, press [START/STOP] once again to stop playing.

3. Accompaniment volume

During playing, user can adjust the volume of accompaniment and the drum sound.

- 1). In song mode, press [PAGE] key to enter into accompaniment volume setting; Accompaniment: the three LED shows AXX (XX refers to accompaniment volume value);

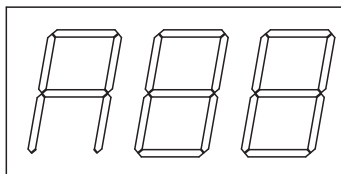

Percussion: the three LED shows DXX (XX refers to drum volume value);

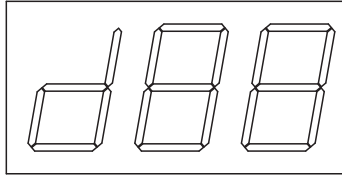

2). Press [+/-] key to switch the accompaniment/volume (0-32, non-cycle).

4. Tempo

- 1). When playing DEMO SONG, press [SET UP] key to enter into Tempo setting, the TEMPO LED lights up;
- 2). Press [+/-] key to change the song tempo.

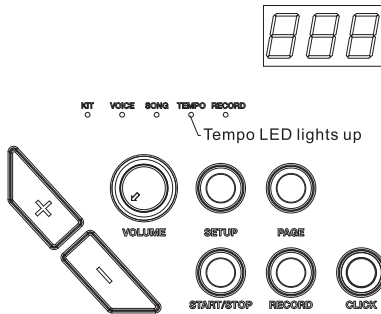

Metronome

This module has only 1 click voice.

(1) Metronome function switch

Press [CLICK] key to open or close metronome function, after [CLICK] is pressed down, CLICK LED will light on, the three LED shows the “beats”, e.g. 4-4, press [+/-] key to switch “beats”.

Note: during playing the songs, the metronome is closed.

(2) Click volume

After [CLICK] is pressed down, press [PAGE] key, it shows “click volume” interface, the three LED shows LXX (XX refers to volume value), press [+/-] key to switch the click volume.

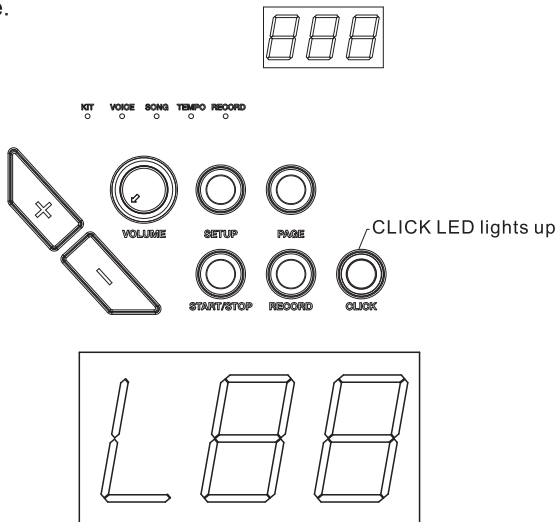

Record and replay

Record quickly

- 1). Press [RECORD] button, and [RECORD] LED lights up and flashes. It shows “REC” .
- 2). Strike the pads to start recording or record only the drum sound of the song being played.
- 3). Press [RECORD] button to stop recording. [RECORD] LED lights off. The song or the user's performance has been recorded.

Note:

- 1). During recording, the metronome function will not automatically start. If user needs to start the metronome function, user can press [CLICK] button before recording instead of pressing it after recording.
 - 2). The metronome sound can not be recorded.
 - 3). If user is not satisfied with the recorded result, press [RECORD] to restart recording.
- (Note: this module supports the recording function, but not saving function. The recorded data will cover the former data, and all the data will not be saved after the module is powered off).

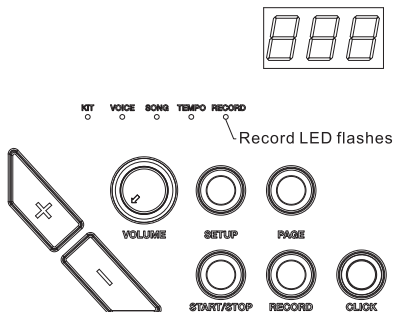

Play recording

Press and hold the [RECORD] button, the RECORD LED lights up, press [START/STOP] button to replay the recorded song, press [START/STOP] button again to stop the recorded song.

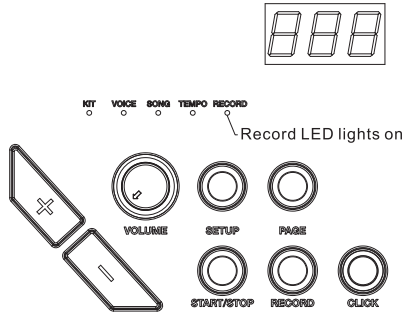

4. MIDI setting

This equipment is compatible with various MIDI devices and can be used as trigger device or audio source. It is also compatible with part of GM standard, and can be used with many audio sequencer softwares together.

MIDI connection

MIDI OUT: sends the external MIDI signal when connecting with external MIDI devices.

Connect with external audio source equipment

This equipment can send its various information via channel 10, including: trigger notes, force, hi-hat pedal performance and status, etc.

(Note: the song replaying and metronome information can not be sent)

Use the external audio sequencer to record the performance

- 1). Connect external audio sequencer or PC via MIDI OUT or USB.
- 2). Set the equipment of channel 10 in the audio sequencer or in the sequence software, and then start recording.
- 3). Play the pads.
- 4). Stop the performance and recording, and listen to the performance.

5. Trouble shooting

Problem	Reason
No sound	Please confirm the volume knob is not turned off
Pad has no sound	1.confirm the pad connection is correct. 2.confirm the pad volume is not set to 0
Metronome has no sound	Confirm the metronome volume is not set to 0
DEMO SONG has no sound	Confirm the DEMO SONG volume is not set to 0

6. Audio source specification

Max polyphony:32

Drum kits: 10 preset drum kits: KIT01-10

Voice: 108 voices (DRUMS, PERCUSSION, SFX)

Audio sequencer: DEMO SONG 10

Recording: real time recording, but can not be saved.

Tempo: 30bpm-280bpm

Display: three LED (red or green)

Connection: Phone stereo out connector(1/8"), AUX IN stereo connector(1/8"),

Audio output connector(1/4" L/mono),

MIDI OUT

Power supply: DC 12V internal + external

Dimensions: 135(L)x132.5(W)x99.5(H)

Weight: 0.35Kg or so

(the specification is subject to change without prior notice.)

7. DRUM KIT LIST

NO.	PRESET DRUM KIT
1	POP1
2	POP2
3	ROCK
4	FUNK
5	LATIN
6	JAZZ
7	DANCE
8	MARCHING
9	PERCUSSION1
10	PERCUSSION2

8. VOICE LIST

BASS DRUM	
NO.	NAME
1	KICK1
2	KICK2
3	KICK3
4	KICK4
5	KICK5
6	JAZZKICK
7	ELE KICK
8	MARCHING KICK
SNARE	
NO.	NAME
9	SNARE1
10	SNARE2
11	SNARE3
12	SNARE4
13	SNARE5
14	BRUSH SNARE
15	ELE SNARE

35	ELE TOML
HI-HAT	
NO.	NAME
36	CLOSED HH1
37	CLOSED HH2
38	CLOSED HH3
39	CLOSED HH4
40	CLOSED HH5
41	CLOSED HH6
42	ELE CLOSED HH
43	OPEN HH1
44	OPEN HH2
45	OPEN HH3
46	OPEN HH4
47	OPEN HH5
48	OPEN HH6
49	ELE OPEN HIHAT
50	HHP1
51	HHP2

69	SCRATCH PULL
70	STICK
71	SQUARE CLICK
72	METRONOME CLICK
73	METRONOME BELL
74	HAND CLAP
75	TAMBOURINE
76	COWBELL
77	VIBRASLAP
78	HI BONGO
79	LOW BONGO
80	MUTE HI CONGA
81	OPEN HI CONGA
82	LOW CONGA
83	HI TIMBALE
84	LOW TOMBALE
85	HI AGOGO
86	LOW GAOAO
87	CABASA

16	MARCHING SNARE
17	SIDESTICK
	TOM
NO.	NAME
18	TOM1H
19	TOM1M
20	TOM1L
21	TOM2H
22	TOM2M
23	TOM2L
24	TOM3H
25	TOM3M
26	TOM3L
27	TOM4H
28	TOM4M
29	TOM4L
30	BRUSH TOMH
31	BRUSH TOMM
32	BRUSH TOML
33	ELE TOMH
34	ELE TOMM

52	HHP3
53	HHP4
54	HHP5
CYMBAL	
NO.	NAME
55	CRASH1
56	CRASH2
57	CRASH3
58	SPLASH CYMBAL
59	MARCHING CYMBAL
60	ELE CYMBAL
61	RIDE1
62	RIDE2
63	ELE RIDE
64	RIDE BELL1
65	RIDE BELL2
PERCUSSION	
NO.	NAME
66	HI Q
67	SLAP
68	SCRATCH PUSH

88	MARACAS
89	SHORT HI WHISTLE
90	LONG LOW WHISTLE
91	SHORT GUIRO
92	LONG GUIRO
93	CLAVES
94	HI WOOD BLOCK
95	LOW WOOD BLOCK
96	MUTE CUICA
97	OPEN CUICA
98	MUTED TRIANGLE
99	OPEN TRIANGLE
100	SHAKER
101	JINGLE BELL
102	BELL TREE
103	CASTANETS
104	MUTED SURDO
105	OPEN SURDO
106	TIMPANI1
107	TIMPANI2
108	TIMPANI3

9.GM PERCUSSION LIST

GM Percussion List

Note No.	Standard name	Voice No.	Voice Name
27—D#1	High Q	66	High Q
28— E1	Slap	67	SLAP
29—F1	Scratch Push	68	SCRATCH PUSH
30—F#1	Scratch Pull	69	SCRATCH PULL
31—G1	Sticks	70	STICKS
32—G#1	Square Click	71	CLIP
33—A1	Metronome Click	72	METRONOME CLICK
34—A#1	Metronome Bell	73	METRONOME BELL
35—B1	Acoustic Bass Drum	3	ACKICK
36—C2	Bass Drum 1	1	KICK1
37—C#2	Side Stick	17	SRSTD
38—D2	Acoustic Snare	9	SNCOMBO3
39—D#2	Hand Clap	74	CLAP1
40—E2	Electric Snare	15	ESN7
41—F2	Low Floor Tom	26	TOMMSTD
42—F#2	Closed Hi Hat	36	CHH3
43—G2	High Floor Tom	20	TOM8
44—G#2	Pedal Hi-Hat	50	PHH2
45—A2	Low Tom	19	TOM1
46—A#2	Open Hi-Hat	43	OHHSTD
47—B2	Low-Mid Tom	28	TOM7
48—C3	Hi-Mid Tom	18	TOM6
49—C#3	Crash Cymbal 1	55	CRSHSTD1
50—D3	High Tom	27	TOM3
51—D#3	Ride Cymbal 1	61	RIDESTD
52—E3	Chinese Cymbal	X	CNCYMBAL
53—F3	Ride Bell	64	RBLLSTD
54—F#3	Tambourine	75	TMBRN1
55—G3	Splash Cymbal	58	SPLSH1
56—G#3	Cowbell	76	COWBLL1

57—A3	Crash Cymbal 2	57	LTCRSH1
58—A#3	Vibraslap	77	VSLP03
59—B3	Ride Cymbal 2	62	RIDE1
60—C4	Hi Bongo	78	HIBNGO01
61—C#4	Low Bongo	79	LOBNGO
62—D4	Mute Hi Conga	80	MHCNGA
63—D#4	Open Hi Conga	81	OHCNGA01
64—E4	Low Conga	82	LOCNGA01
65—F4	High Timbale	83	HTMBL1
66—F#4	Low Timbale	84	L0TMBL1
67—G4	High Agogo	85	HAGOGO1
68—G#4	Low Agogo	86	LAGOGO1
69—A4	Cabasa	87	CABASA1
70—A#4	Maracas	88	MRCAS1
71—B4	Short Whistle	89	SWHSL1
72—C5	Long Whistle	90	LWHSL1
73—C#5	Short Guiro	91	SGUIRO
74—D5	Long Guiro	92	LGUIRO
75—D#5	Claves	93	CLV
76—E5	Hi Wood Block	94	HWBLK
77—F5	Low Wood Block	95	LWBLK
78—F#5	Mute Cuica	96	MCUICA
79—G5	Open Cuica	97	OCUICA
80—G#5	Mute Triangle	98	MTRNGL
81—A5	Open Triangle	99	OPNTRNGL
82—A#5	Shaker	100	SHAKER
83—B5	Jingle Bell	101	JINGLEBELL
84—C6	Bell Tree	102	BELLTREE
85—C#6	Castanets	103	CASTANETS
86—D6	Mute Surdo	104	MUTESURDO
87—D#6	Open Surdo	105	OPNSURDO

10.DEMO SONG LIST

NO.	NAME	METER
1	FUNK	4/4
2	ROCK1	4/4
3	ROCK2	4/4
4	METAL	4/4
5	SLOWROCK	6/8
6	BLUES	4/4
7	COUNTRY	4/4
8	BOSSA	4/4
9	REGGAE	4/4
10	WALTZ	3/4

Service information

If you have a problem with your Carlsbro product or think it has developed a fault you should first carefully check the Trouble Shooting section in this guide. If this does not solve the problem or if the product is physically damaged, contact your local dealer or distributor for service details.

Should it be recommended you return the product to your nearest Carlsbro Service Centre you must first contact them.

You will be asked for the product type and serial number. You will then be given a returns Authorisation (RA) number. Pack the unit in its original carton to protect it from shipping damage.

You must have the Returns Authorisation number clearly marked on the outside of the carton or we may refuse the delivery.

Carlsbro cannot be held responsible for damage resulting from the equipment being packed incorrectly.

Label the equipment clearly with your name and address and include a clear description of the fault. The more information you supply helps the service engineer, minimising repair cost when out of warranty.

Please write your serial number here for future reference.

SCC Audio Ltd

Unit 11, Torc: MK, Chippenham Drive, Kingston,
Milton Keynes, MK10 0BZ, United Kingdom
Tel- +44(0)1908 281072

Web: www.carlsbro.com Email: info@carlsbro.com